

REVISIONS				
REV	DESCRIPTION	DATE	DRAWN	CK'D
A	AS PER ECN NO 1085111	07/11/14	L&T	MWS

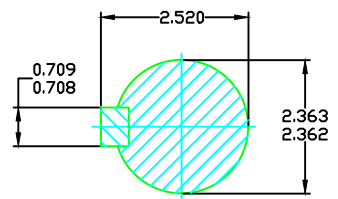
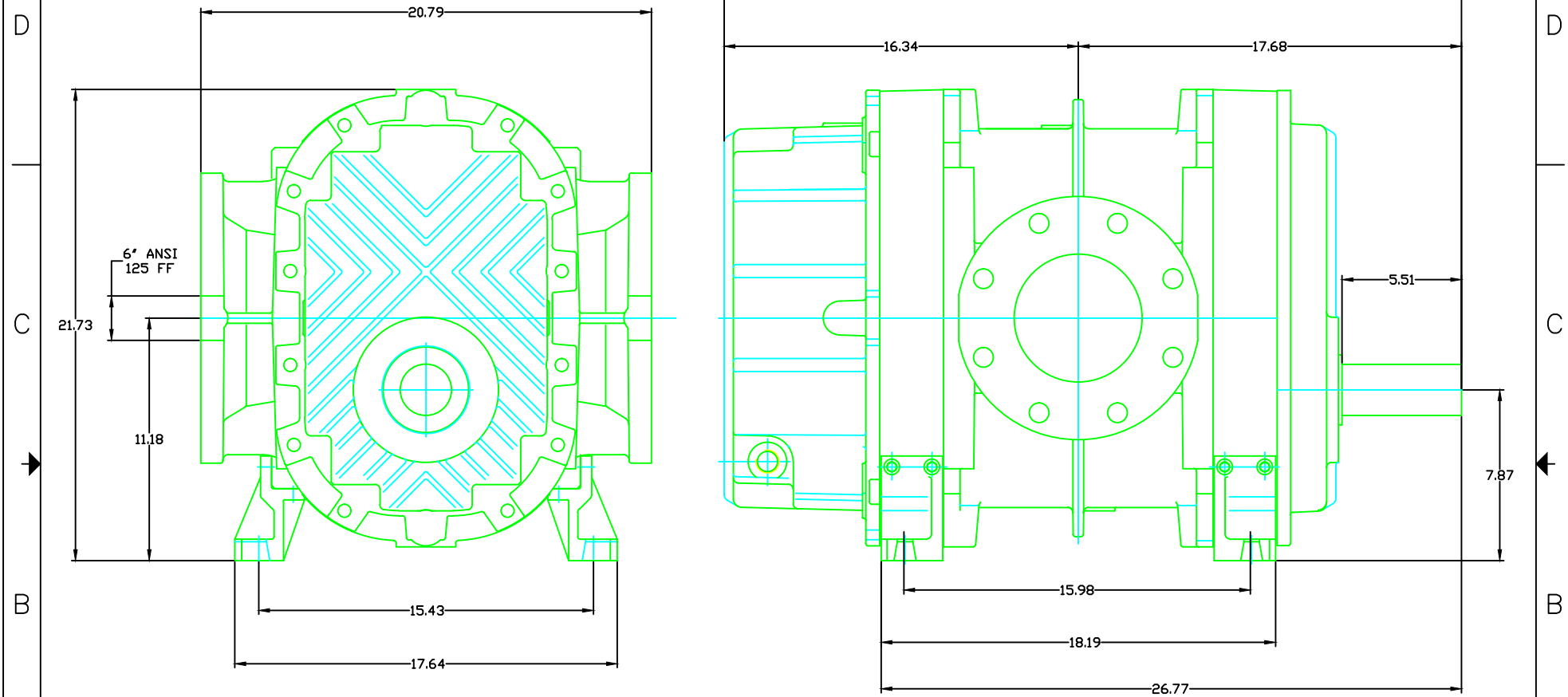

TOTAL WEIGHT 794 lbs

FINISH OF CHAMFERS & FILLETS TO CONFORM TO ROUGHEST ADJACENT AREA. SURFACE ROUGHNESS MAX. PER ASME B46.1 SPEC. FULL THD DEPTHS ARE MINIMUM.		CONFIDENTIAL - THE INFORMATION CONTAINED IN THIS DOCUMENT IS THE PROPERTY OF GARDNER DENVER, INC. IT IS NOT FOR PUBLIC DISCLOSURE. POSSESSION OF THE INFORMATION DOES NOT CONVEY ANY RIGHT TO LOAN, SELL OR DISCLOSE THE INFORMATION. UNAUTHORIZED REPRODUCTION OR USE OF THE INFORMATION IS PROHIBITED. THIS DOCUMENT IS TO BE RETURNED TO GARDNER DENVER, INC. UPON THE COMPLETION OF THE PURPOSE FOR WHICH IT IS LOANED OR UPON REQUEST.	
UNLESS OTHERWISE SPECIFIED DIMENSIONS ARE IN INCHES TOL. ON DECIMALS: .X = ±.05 TOL. ON DECIMALS: .XX = ±.02 TOL. ON DECIMALS: .XXX AS SPECIFIED TOL. ON ANGLES: ± 0°-30'		DIMENSIONING AND TOLERANCING PER ASME Y14.5-2009 THREADS PER ASME B1.1 GAGING SYSTEM 21 U.O.S., ANSI B1.20.1 & B1.20.3	
FIRST ANGLE PROJECTION		Gardner Denver Gardner Denver Inc. Quincy, IL.	HEAT TREATMENT ENG. REF: 281525-0000
DWN BY L&T 07/11/14 CK'D BY MWS 07/11/14		TITLE OUTLINE-BARE UNIT RBS 95 VERTICAL	SIZE C ENGR. APPROVAL - DWG NO. 325RBS800 REV A SCALE 1:1 SHEET 1 OF 1